



AUTOMOTIVE PTY LTD

25 Metrolink Circuit West Campbellfield
Victoria 3061 Australia
ABN: 48166279670 ACN: 166279670

Phone: +61 3 9930 0100
Fax: +61 3 8339 2270
Email: sales@saasautomotive.com.au

Item No: DB1001
(up to 4 Ports)
Thread Size: 1/8" BSP

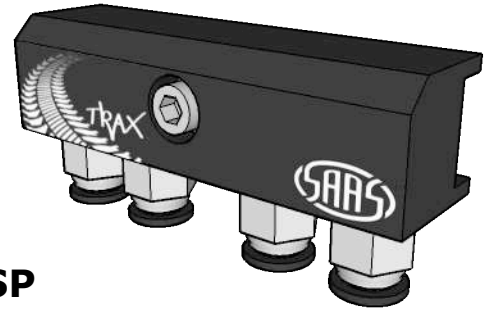

Differential/Gearbox Breather Kit Fitting Guide.

CAUTION: If you do not have basic mechanical skills then **do not** attempt to fit this kit.

IMPORTANT: It is **your** responsibility to make sure the air filters in this kit are not obstructed in any way. Incorrect fitting could result in damage to your differential or gearbox and will **not** be covered under warranty!

Step 1: Locate and remove factory breathers on your differential/gearbox and check that the fittings in this kit will suit your application. Some vehicles use rubber hose for their breather system and may require an optional barb joiner. Common sizes for joiners you may need: **1/4" to 3/16"** or **1/4" to 5/16"** ect. (SAAS breather hose will fit 1/4" barb fittings)

Step 2: Assemble the required parts to the breather (**do not over tighten parts**) and find a place up high (usually in the engine bay) to mount the breather. Most engine bays will have spare M6 threads that can be used to mount the breather. The filters on the back of the breather must have a 3mm (minimum) clearance from the mounting surface to ensure correct operation. **Fitting Tip:** Try to mount the breather away from your cabins air intake, this will prevent fluid vapour from your diffs/gearbox entering your cabins air vents.

Step 3: Install the hose fittings to your differential/gearbox and run the supplied hose up to the breather and secure hose with supplied cable ties. Make sure to allow for differential travel when running the breather hose and keep away from exhaust heat! For vehicles with large differential travel use the supplied spring hose.

Step 4: Once installation is complete you should have some left over hose that can be used with the supplied hose joiner fittings to make an emergency repair kit if you should need it when off-roading.

Manifold assembly

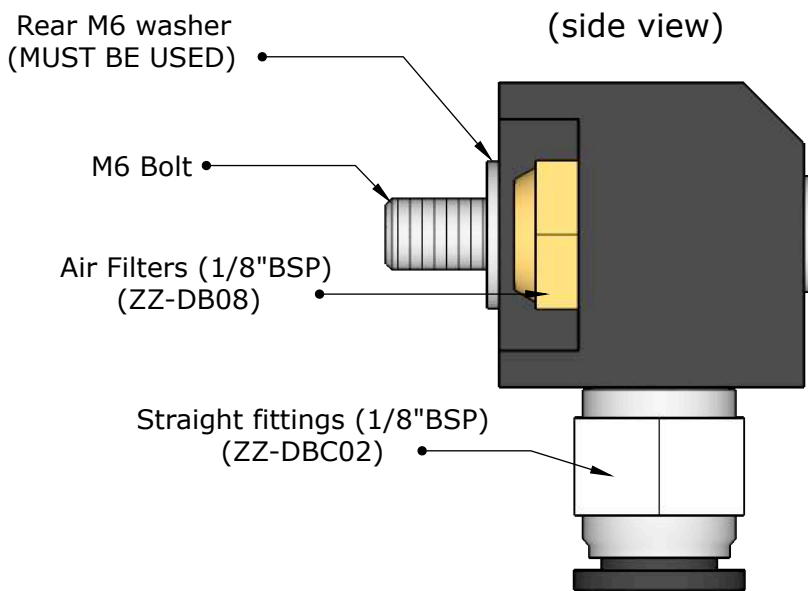



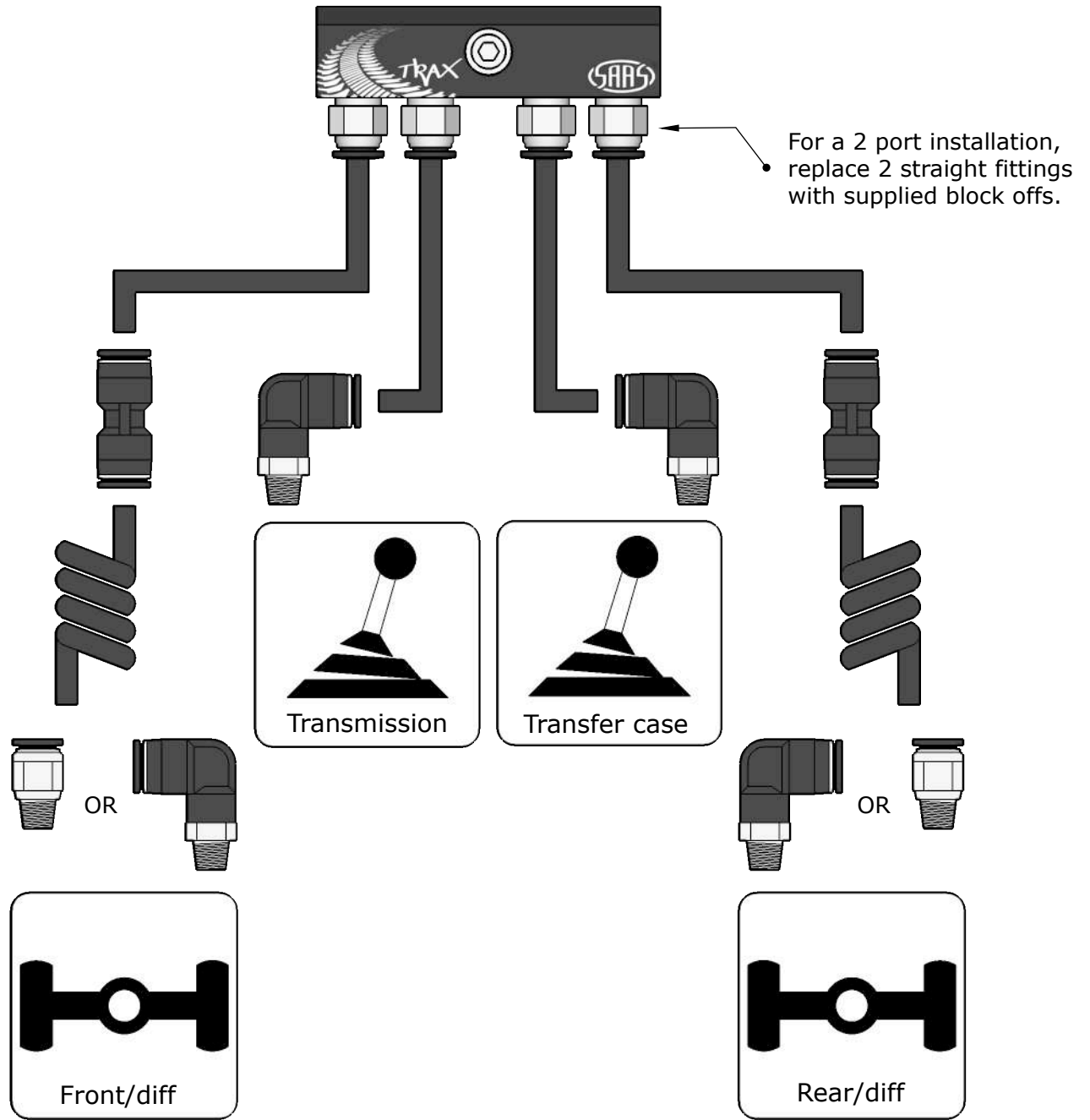

Typical layout (4 port installation)

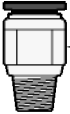

Item No:

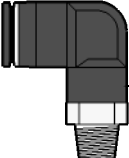
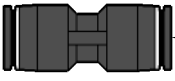
Components

- ZZ-DBC02  • Straight push in fittings (use for manifold assembly/differentials)
- ZZ-DBC09  • 1/8" BSP block off (use to block any used ports)
- ZZ-DBC13  • Elbow push in fitting (use for differential/gearbox and transfer case)
- ZZ-DBC05  • Push in hose joiner (use to join spring hose to straight hose and for repairs)
- ZZ-DBC07  • Spring hose (use for vehicles with large differential travel)